

# KUBOTA EXCAVATOR KX085-5



Engine output:  
**66.6 PS / 49.0 kW**

Machine weight:  
Mono: **8,392 kg**  
2-Piece boom: **9,097 kg**

# PERFORMANCE

## Reliable performance and operability.

A next-generation excavator, the KX085-5's advanced Kubota engine and robust hydraulic system provide the reliability and operability you need to perform a wide range of jobs.

### TWO PROPORTIONAL AUXILIARY CIRCUITS WITH ADJUSTABLE MAXIMUM OIL FLOW (AUX1/AUX2)

The KX085-5 is equipped with two proportional auxiliary circuits—AUX1 and AUX2—with maximum oil flow settings. These settings can be conveniently adjusted from the digital panel without additional tools or complex manual adjusting procedures.



### HYDRAULIC SYSTEM WITH LOAD SENSING PUMPS

Kubota's load-sensing hydraulic system ensures smoother operation, regardless of load size. It allows hydraulic oil to flow according to the specific range of the operator's lever motion. As a result, it reduces fuel consumption and delivers greater overall operating performance. The 2-pump L/S system improves the overall smoothness of operations when moving the front attachments simultaneously, moving front attachments while travelling, and operating special attachments that are independently powered – such as a brush cutter.

### DOZER BLADE FLOAT

You don't need to adjust the dozer height to make a clean ground surface—after backfilling, just travel backward along the covered ditch with the dozer in the float position. Ground finishing work is now fast and easy.

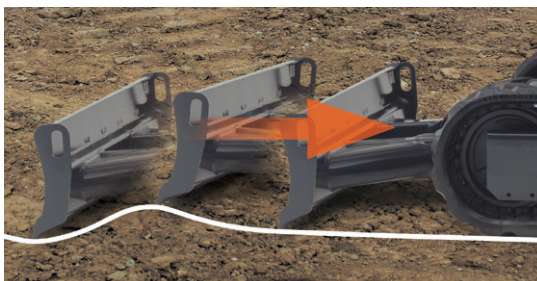



## KUBOTA ORIGINAL DI ENGINE WITH CRS AND DPF MUFFLER

Equipped with Kubota's V3307 stage V compliant direct injection engine with CRS and DPF. The improved DPF reduces maintenance by increasing the service intervals up to 6000 hours for both the regeneration filter and ash cleaner.

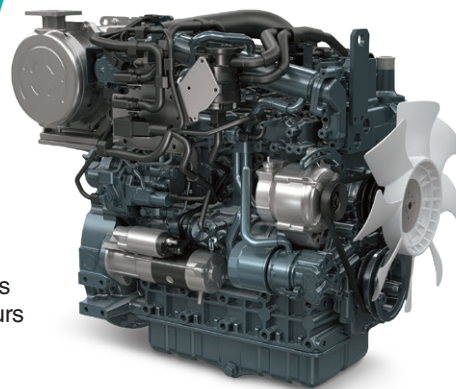

### AUTOMATIC REGENERATION SYSTEM

You'll never need to stop work to clean the DPF muffler. Before soot can reach a critical level, the Automatic Regeneration System automatically performs DPF regeneration (PM combustion stroke).

### AUTOMATIC ACTIVATION OF 3rd LINE HYDRAULIC RETURN

No more climbing down from the cab and reaching under the bonnet to manually open and close the 3rd line hydraulic return. The KX085-5 feature an electronically controlled 3rd line hydraulic return that is automatically activated when the operator selects breaker mode on the digital panel in the cab.



### AUTO IDLING SYSTEM

When the control levers are left in neutral for longer than 4 seconds, engine RPM is automatically reduced to idling speed. When the levers are moved again, engine RPM immediately rises to the pre-set level. You'll save energy and running costs, as well as reduce noise and exhaust emissions.

### AUTO ENGINE STOP

The Engine Auto Stop system comes fitted as standard. The Engine turns off automatically when it's been left idling too long. You can set the Idling time to suit you. This innovative features reduce noise and exhaust emissions, in addition to saving energy and running costs.

### AUTO SHIFT

The KX085-5 is fitted with an advanced two-speed auto-shift feature, which automatically adjusts speed and traction force depending on load size and terrain to enhance travel performance and ensure smooth and easy operation.

# COMFORT / EASY OPERATION

A luxurious cabin with wider entrance, generous legroom, and a deluxe seat ensure day-long comfort and easy operability.

## DOUBLE ADJUSTABLE AIR SUSPENSION SEAT

As part of the new design, the cabin is now equipped with a seat with a slide that can be double-adjusted to improve comfort. The joystick consoles on the left and right sides of the seat also can be adjusted independently of the seat to match individual operator requirements. Standard ISO-compliant air suspension seat reduces vibrations to provide optimum operator comfort. An electric seat-height adjustment system simplifies and improves adjustment by the operator.



- A.** Double adjustable air suspension seat
- B.** New full-colour LCD screen
- C.** CUP holder
- D.** Mobile phone holder / USB charger

## MOBILE PHONE HOLDER/USB CHARGER

A convenient holder for your phone and a nearby USB charging port keep your phone within easy reach and fully charged.



## LOW NOISE

A quieter cabin provides a more stress-free working environment. The low noise level protects the operator from engine noise and other loud sounds. \*LpA: 72dB

# AIR CONDITIONER

Stay cool on the hottest days and warm on the coldest. You'll enjoy year-round comfort, thanks to the enhanced air flow and ducting that improves the air circulation in the cabin. Also the new air vents work as a demister giving greater visibility and enhanced safety.



# NEW FULL-COLOUR LCD SCREEN

A full-colour, high-resolution 7" LCD screen provides with a single glance all the information the operator needs to operate the excavator. An intuitive interface ensures quick understanding and easy access to the excavator's various functions, including AUX flow adjustment. Important maintenance functions are also displayed, as are detailed alerts for improper machine functions and abnormalities. The new jog dial is both intuitive and easy to use. Even first-time operators will be able to quickly access all important information.

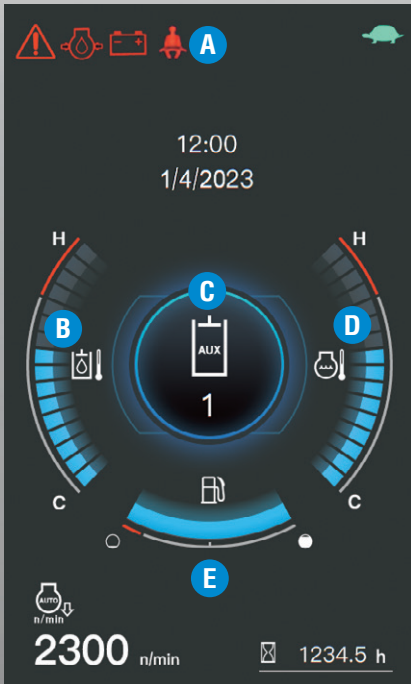

Standard Monitor Display

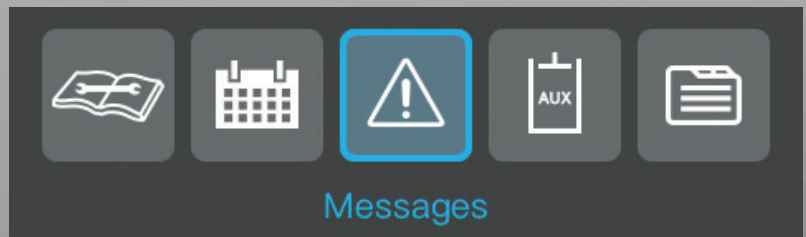

- A. Alert Indicator
- B. Hydraulic Temperature
- C. AUX mode
- D. Water Temperature
- E. Fuel Level

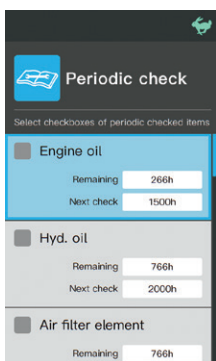

Periodic Check

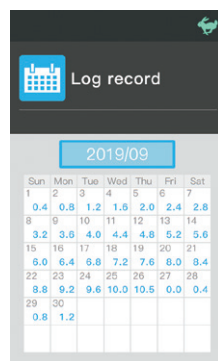

Log Record

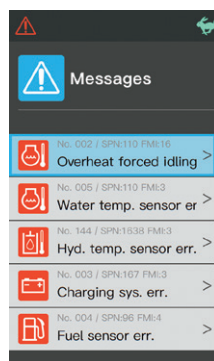

Message Mode

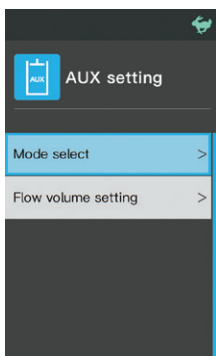

AUX Setting

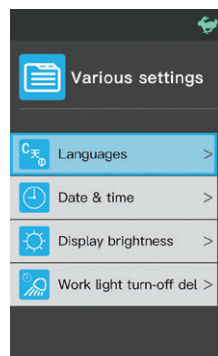

Various Setting

- A. Menu Key
- B. Return Key
- C. Jog Dial
- D. Working Light
- E. Beacon Light
- F. Auto Idle & Engine Stop
- G. Overload Warning
- H. Wiper
- I. Rear-view Camera
- J. Washer Fluid
- K. Travel Alarm (Opt.)



# SERVICE / SAFETY

Fast, easy maintenance combined with advanced technology ensure both operator and excavator safe and secure.

## TRIPLE OPENING BONNET

Kubota has made routine maintenance extremely simple by consolidating primary engine components onto one side for easier access. Engine and other vital components can be inspected quickly and easily.

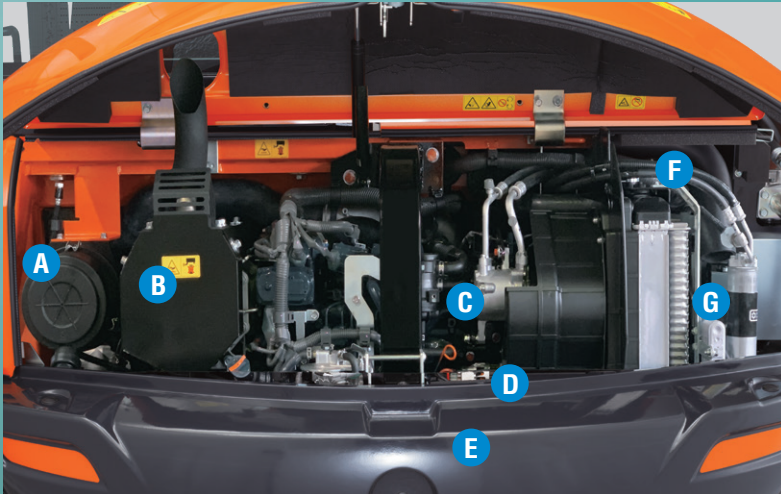

**A. Dual Element Air Cleaner**  
**B. DPF Muffler**  
**C. Fuel Filter**  
**D. Alternator**

**E. Starter Motor**  
**F. Control Valves**  
**G. Hydraulic Return Oil Filter**

## EASY MAINTENANCE

Parts that require routine maintenance and inspection such as the engine oil level and V-belt are easy to access. In addition, all filters are located near the bonnet opening to simplify their replacement.

## BOLT-ON CAB HANDRAIL

The handrail is bolted to the cab to allow for quick and easy replacement in the event it get damaged.

## TWO-PIECE HOSE DESIGN

Two-piece hose design for the dozer blade reduces hose replacement time by nearly 60% compared to one piece hose. This design virtually eliminates the need to enter the machine for maintenance.

## ELECTRIC REFUELLING PUMP

The KX085-5's standard diesel refueling pump includes an auto-stop function that minimizes spillage and increases safety. Complete tank filling takes approximately three minutes.

## TIGHT TAIL SWING

The KX085-5 is designed with a shorter rear overhang, ensuring improved workability in restricted space, increased versatility, and better stability. The rear overhang also features cast-iron protectors, which significantly reduce damage to the machine in space restricted work sites.



## LED WORKING LIGHTS

The LED work light can be programmed to turn off 30 seconds to 2 minutes after the engine has stopped. This allows the operator to exit the machine and walk away safely under full illumination.

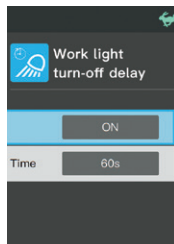

## REAR-VIEW CAMERA

The Rear-View camera which is now standard significantly improves visibility towards the rear of the excavator by displaying the view on the 7" LCD screen in the cab.



## SEAT BELT ALARM AND HIGH-VISIBILITY SEAT BELT

The bright orange seat belt visually reminds operators to fasten it before turning on the engine. Should the operator forget, a warning function will prompt the operator to fasten it.



## SAFETY (ANTI-DROP) VALVE ON THE BOOM AND ARM LOWERING

The KX085-5 is fitted with a boom and arm lowering control device as standard.



## COMPACT MACHINE WIDTH

The KX085-5's narrow 2200 mm width makes it ideal for working in close conditions, and much easier to transport between job sites.

# 2-PIECE BOOM VERSION

The KX085-5 can be equipped with a two-piece boom so you can take on tougher jobs in a wider range of sites.



**A** Extended reach



Close digging capability



**B** High dumping reach



**C** Efficient vertical digging

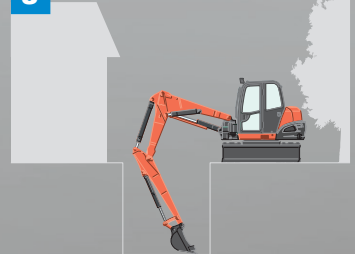

## EASY BOOM CONTROL

The user-friendly design and location of the 2-piece boom pedal makes operation extremely simple. Located to the left of the driving pedals, the operator simply needs to flip the footpad, and depress the right side of the pedal to extend the boom, or the left side to retract it. This feature greatly simplifies the footwork necessary to smoothly operate the boom.



## 2-PIECE BOOM'S DYNAMIC WORKING RANGE

The 2-piece boom offers a versatile working range so you can reach further, deeper, closer and anywhere in between.

### **A. Expanded working range**

The versatile 2-piece boom offers a long reach and close retraction to make levelling large areas more efficient and productive. Plus, it's easy to dig close to the machine, eliminating the need for constant repositioning. It's particularly effective when working in narrow spaces.

### **B. Impressive dumping range**

The 2-piece boom enables you to dump farther and higher, and offers a high bucket bottom position, making it smooth and easy to dump into Lorries without repositioning the excavator.

### **C. Efficiency in narrow spaces**

When space is restricted, the 2-piece boom manoeuvres easily to simplify vertical digging and efficiently make deep walls at 90° angles. And, it offers a compact front swivel radius to make turning and lifting operations in tight spaces even easier.

## SMOOTH SIMULTANEOUS OPERATION

Kubota's 2-piece boom offers reliably smooth and fast performance. Its innovative hydraulic mechanism enables the operator to easily run the arm, boom, bucket, and swivel simultaneously, boosting work efficiency and increasing productivity.



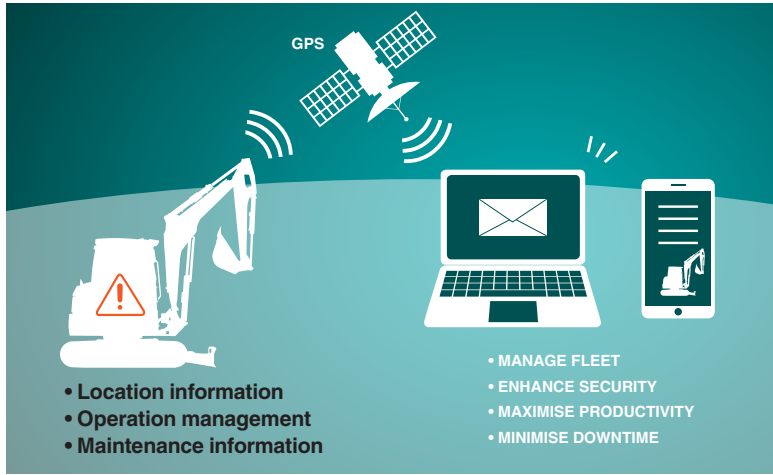

# Kubota Tracking System

Kubota Tracking System is the smarter and easier way to stay informed about your Kubota excavators. Anywhere. Anytime. From any PC, laptop, tablet or smartphone. Kubota's real-time solution not only helps you to assess your fleet's operational performance, it can also improve security, make it easier to minimise downtime and plan maintenance for maximised productivity.

## KUBOTA ORIGINAL ANTI-THEFT SYSTEM

Your KX085-5 is protected by Kubota's industry-leading anti-theft system. Only programmed keys will enable the engine to start up. Attempting to start with an un-programmed key will activate the alarm. Newly enhanced features include an alert to remind the operator to extract the key after operation, and an LED alert to prevent potential theft.



## Standard equipment

<b>Safety system</b>
Engine start safety system on the left console
Travel motor with disc brake
Swivel motor with disc brake
Overload warning buzzer
Kubota original anti-theft system
Anti-drop valve on the boom (ISO 8643)
Anti-drop valve on the arm (ISO 8643)
Bracket and harness for 1st and harness for 2nd beacon light
Engine auto stop
Side/Rear mirrors (left, right and rear)
Rear-view camera
<b>Working equipment</b>
Auxiliary hydraulic circuit (AUX1 and AUX2) piping to the arm end
3 LED working lights on cabin and 1 LED light on the boom
2100 mm arm
<b>Cabin</b>
ROPS (Roll-over Protective Structure, ISO12117-2)
OPG (Operator Protective Guard, Top Guard) Level1
Double adjustable air suspension seat
Retractable orange seatbelt with alert function
Hydraulic pilot control levers with adjustable wrist rests
Travel levers with foot pedals
Air conditioning
Cabin heater for defrosting and demisting
Emergency exit hammer
Front window power-assisted with gas damper
Full colour LCD panel
USB charger
12 V power source
2 speakers and radio aerial
Location for radio
Kubota tracking system*
Front window guard mounting points
Mobile holder
Cup holder
<b>Engine/Fuel system</b>
Double-element air filter
Engine electric fuel pump
Auto idling system
Tank electric refueling pump
Water separator with filter

<b>Undercarriage</b>
450 mm rubber track
1 x upper track roller (double flange type)
5 single-flange track rollers on each track
2-speed travel switch on dozer lever
<b>Hydraulic system</b>
2-speed travel with auto-shift
Dozer blade with float function
Pressure accumulator
Hydraulic pressure checking ports
Electronically controlled third line hydraulic return
2-pump load sensing system
Adjustable maximum oil flow on auxiliary circuits (AUX1 and AUX2)
Auxiliary switch (AUX1) on right control lever (proportional)
Auxiliary switch (AUX2) on left control lever (proportional)

## Optional equipment

<b>Undercarriage</b>
450 mm steel track (+ 50 kg)
600 mm steel track (+ 100 kg)
1750 mm arm (- 22 kg)
<b>Safety system</b>
Anti-drop valve unit on the dozer
<b>Others</b>
OPG (Operator Protective Guard, Front Guard & Top Guard Level II, ISO 10262)
Beacon light
Additional counterweight for standard boom (+ 200 kg)
Additional counterweight for 2-piece boom (+ 260 kg)
Special paint upon request

### Fluorinated greenhouse gases

Air conditioner gas contains fluorinated greenhouse gases.

CAB model	Industrial designation	Quantity (kg)	CO <sub>2</sub> equivalent (ton)	GWP
KX085-5	HFC-134a	0.98	1.41	1430

(Global Warming Potential: GWP)

\* Specification varies from country to country, please contact your local dealer.

# Specifications

\* With 75 kg operator, 176.6 kg original KUBOTA bucket and fully served

Model		MONO	2PB
Operating weight*1	kg	8467	9172
Bucket capacity, std. CECE	m <sup>3</sup>	0.21	0.21
Bucket width (without teeth)	mm	800	800
<b>Engine</b>			
Manufacturer		KUBOTA	KUBOTA
Model		V3307-CR-TE5-BH-1	V3307-CR-TE5-BH-1
Type		Water-cooled, diesel engine E-CDIS (with CRS and DPF)	Water-cooled, diesel engine E-CDIS (with CRS and DPF)
Emission standard		EU Stage V	EU Stage V
Output (ISO 14396:2002)*2	PS (kW) / rpm	66.6 (49.0) / 2000	66.6 (49.0) / 2000
Output ISO 9249 NET*2	PS (kW) / rpm	63.2 (46.5) / 2000	63.2 (46.5) / 2000
Number of cylinder		4	4
Bore × Stroke	mm	94 × 120	94 × 120
Displacement	cc	3331	3331
Fuel*3		Diesel fuel conforming to EN590 / HVO conforming to EN 15940	
Overall length	mm	6450	6940
Overall height	mm	2540	2540
Swivelling speed	rpm	9.8	9.8
Rubber shoe width	mm	450	450
Tumbler distance	mm	2300	2300
Dozer size (width × height)	mm	2200 × 500	2200 × 500
<b>Hydraulic pumps</b>			
P1, P2		Variable displacement pump	Variable displacement pump
Flow rate	ℓ / min	84.6 × 2	84.6 × 2
Hydraulic pressure	MPa	27.4	27.4
Max. digging force (arm / bucket)	kN	38.1 / 65.2	38.1 / 65.2
Boom swing angle	deg	70 / 60	70 / 60
<b>Auxiliary circuit (SP1)</b>			
Flow rate	ℓ / min	100	100
Hydraulic pressure	MPa	20.6	20.6
<b>Auxiliary circuit (SP2)</b>			
Flow rate	ℓ / min	55.8	55.8
Hydraulic pressure	MPa	20.6	20.6
Hydraulic reservoir (tank)	ℓ	75	75
Fuel tank capacity	ℓ	115	115
Max. travelling speed (low / high)	km / h	2.7 / 4.8	2.7 / 4.8
Ground contact pressure	kPa (kgf / cm <sup>2</sup> )	36.7 (0.374)	39.8 (0.406)
Ground clearance	mm	356	356
<b>Noise level</b>			
LpA / LwA (2000 / 14 / EC)	dB (A)	72 / 96	72 / 96
<b>Vibration*4</b>			
<b>Hand arm system (ISO 5349-2:2001)</b>			
Digging / Levelling	m / s <sup>2</sup> RMS	<2.5 / <2.5	<2.5 / <2.5
Driving / Idling	m / s <sup>2</sup> RMS	4.40 / <2.5	4.40 / <2.5
<b>Whole body (ISO 2631-1:1997)</b>			
Digging / Levelling	m / s <sup>2</sup> RMS	<0.5 / <0.5	<0.5 / <0.5
Driving / Idling	m / s <sup>2</sup> RMS	<0.879 / <0.5	<0.879 / <0.5

\*1 With 75 kg operator, 176.6 kg original KUBOTA bucket and fully served.

\*2 With diesel fuel conforming to EN590.

\*3 Note that HVO has lower density than diesel fuels.

\*4 These values are measured under specific conditions at maximum engine speed and can deviate, depending on the operating status.

2100 mm arm  
1750 mm arm

## Working range

### 2-PIECE BOOM VERSION

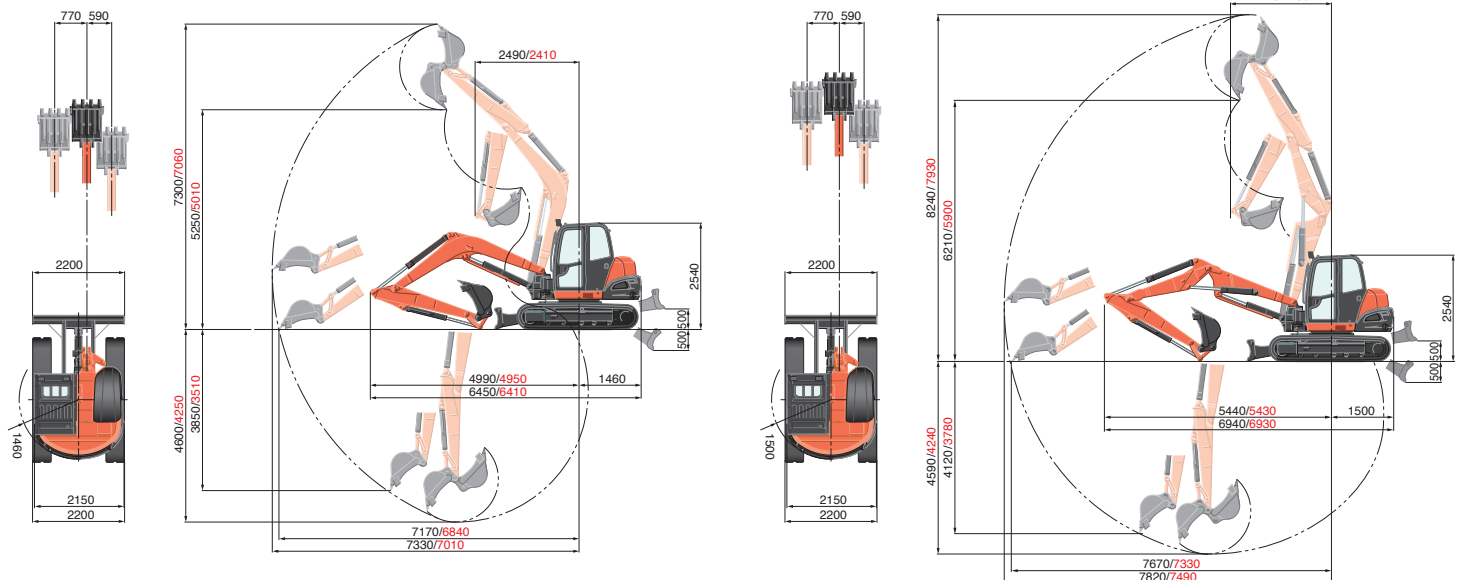

# Lifting capacity

kN (ton)

Model		MONO											
		Lift point radius (min.)			Lift point radius (4m)			Lift point radius (5m)			Lift point radius (Max)		
		Over-front		Over-side	Over-front		Over-side	Over-front		Over-side	Over-front		Over-side
		Blade Down	Blade Up		Blade Down	Blade Up		Blade Down	Blade Up		Blade Down	Blade Up	
5m	1750 Arm				16.7 (1.70)	16.7 (1.70)	16.2 (1.65)						
	2100 Arm				14.2 (1.45)	14.2 (1.45)	14.2 (1.45)						
3m	1750 Arm				20.1 (2.05)	20.1 (2.05)	15.2 (1.55)	17.2 (1.75)	13.7 (1.40)	10.8 (1.10)			
	2100 Arm				18.1 (1.85)	18.1 (1.85)	15.7 (1.60)	16.2 (1.65)	14.2 (1.45)	10.8 (1.10)			
1.5m	1750 Arm				26.0 (2.65)	18.6 (1.90)	13.7 (1.40)	20.1 (2.05)	13.2 (1.35)	10.3 (1.05)	17.0 (1.74)	10.7 (1.09)	8.2 (0.84)
	2100 Arm				24.5 (2.50)	18.6 (1.90)	14.2 (1.45)	19.1 (1.95)	13.2 (1.35)	10.3 (1.05)	15.8 (1.61)	9.3 (0.95)	7.5 (0.76)
1m	1750 Arm				27.4 (2.80)	18.1 (1.85)	13.7 (1.40)	20.6 (2.10)	12.7 (1.30)	9.8 (1.00)			
	2100 Arm				26.0 (2.65)	18.1 (1.85)	13.7 (1.40)	20.1 (2.05)	13.2 (1.35)	9.8 (1.00)			
0m	1750 Arm				28.4 (2.90)	17.6 (1.80)	13.2 (1.35)	21.1 (2.15)	12.7 (1.30)	9.3 (0.95)			
	2100 Arm				27.9 (2.85)	17.6 (1.80)	13.2 (1.35)	21.1 (2.15)	12.7 (1.30)	9.3 (0.95)			
-1m	1750 Arm	37.2 (3.80)	37.2 (3.80)	37.2 (3.80)	27.0 (2.75)	17.2 (1.75)	12.7 (1.30)	20.1 (2.05)	12.7 (1.30)	9.3 (0.95)			
	2100 Arm	28.4 (2.90)	28.4 (2.90)	28.4 (2.90)	27.4 (2.80)	17.2 (1.75)	12.7 (1.30)	20.6 (2.10)	12.3 (1.25)	9.3 (0.95)			
-3m	1750 Arm												
	2100 Arm				15.7 (1.60)	15.7 (1.60)	13.2 (1.35)						

kN (ton)

Model		2PB											
		Lift point radius (min.)			Lift point radius (4m)			Lift point radius (5m)			Lift point radius (Max)		
		Over-front		Over-side	Over-front		Over-side	Over-front		Over-side	Over-front		Over-side
		Blade Down	Blade Up		Blade Down	Blade Up		Blade Down	Blade Up		Blade Down	Blade Up	
5m	1750 Arm	23.0 (2.35)	23.0 (2.35)	23.0 (2.35)	19.6 (2.00)	19.6 (2.00)	17.2 (1.75)	17.6 (1.80)	15.2 (1.55)	11.8 (1.20)			
	2100 Arm				18.1 (1.85)	18.1 (1.85)	17.6 (1.80)	16.7 (1.70)	15.7 (1.60)	12.3 (1.25)			
3m	1750 Arm				23.5 (2.40)	21.1 (2.15)	15.7 (1.60)	18.6 (1.90)	14.7 (1.50)	11.3 (1.15)			
	2100 Arm				22.1 (2.25)	21.6 (2.20)	16.2 (1.65)	18.1 (1.85)	14.7 (1.50)	11.3 (1.15)			
1.5m	1750 Arm				27.4 (2.80)	19.1 (1.95)	14.2 (1.45)	20.1 (2.05)	13.7 (1.40)	10.3 (1.05)	14.7 (1.50)	9.6 (0.98)	7.3 (0.74)
	2100 Arm				26.5 (2.70)	19.1 (1.95)	14.2 (1.45)	20.1 (2.05)	13.7 (1.40)	10.3 (1.05)	13.8 (1.41)	9.5 (0.97)	6.9 (0.71)
1m	1750 Arm				27.4 (2.80)	18.6 (1.90)	13.7 (1.40)	20.6 (2.10)	13.7 (1.40)	10.3 (1.05)			
	2100 Arm				27.0 (2.75)	18.6 (1.90)	13.7 (1.40)	20.1 (2.05)	13.7 (1.40)	10.3 (1.05)			
0m	1750 Arm				26.0 (2.65)	18.1 (1.85)	13.2 (1.35)	19.6 (2.00)	13.2 (1.35)	9.8 (1.00)			
	2100 Arm				26.5 (2.70)	18.1 (1.85)	13.2 (1.35)	20.1 (2.05)	13.2 (1.35)	9.8 (1.00)			
-1m	1750 Arm	27.9 (2.85)	27.9 (2.85)	20.6 (2.10)	22.5 (2.30)	18.1 (1.85)	13.2 (1.35)	17.2 (1.75)	13.2 (1.35)	9.8 (1.00)			
	2100 Arm	22.5 (2.30)	22.5 (2.30)	22.5 (2.30)	24.0 (2.45)	18.1 (1.85)	13.2 (1.35)	18.1 (1.85)	12.7 (1.30)	9.3 (0.95)			
-3m	1750 Arm				6.9 (0.70)	6.9 (0.70)	6.9 (0.70)						
	2100 Arm				11.3 (1.15)	11.3 (1.15)	11.3 (1.15)						

Please note:

- \* The lifting capacities are based on ISO 10567 and do not exceed 75% of the static tilt load of the machine or 87% of the hydraulic lifting capacity of the machine.
- \* The excavator bucket, hook, sling and other lifting accessories are not included on this table.
- \* Standards EN474-1 and EN474-5 require the machine to be fitted with a safety valve on the boom cylinder and an overload warning buzzer for object handling operations.
- \* Specifications are subject to change without notice for purpose of improvement.

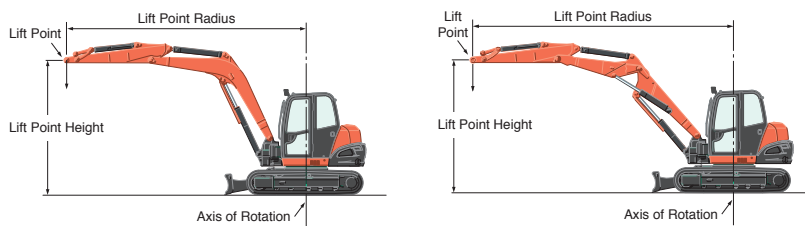

**Kubota Genuine and Approved Parts**  
for maximum performance, durability and safety

★ All images shown are for brochure purposes only.  
When operating the excavator, wear clothing and equipment in accordance with local legal and safety regulations.



#### **KUBOTA EUROPE S.A.S.**

19, rue Jules Verceyusse  
Zone Industrielle - CS50088  
95101 Argenteuil Cedex France  
Téléphone : (33) 01 34 26 34 34  
Télécopieur : (33) 01 34 26 34 99

#### **KUBOTA (U.K.) LTD**

Dormer Road, Thame,  
Oxfordshire,  
OX9 3UN, U.K.  
Phone : (44) 01844-268140  
F a x : (44) 01844-216685

#### **KUBOTA Baumaschinen GmbH**

Steinhauser Straße 100  
66482 Zweibrücken Deutschland  
Telefon : (49) 0 63 32 - 487 - 0  
F a x : (49) 0 63 32 - 487 - 101



<https://www.kubota-eu.com>

